



E4D Dentist
Empowering Dentistry™

"The teamwork approach and consistent messaging from **E4D University's** basic training is brilliant and really makes my team part of the solution. We came back to the practice confident and well-prepared to use the system. The integration of the **Chairside Dental Designer** program will also take my team to new levels of service and support."

The team of Dr. Marvin Berlin and Sherri White, RDA McKinney, TX

"The real-time support is amazing. It is exactly like having someone chairside to work with your case. I have patients in my chair who value their time as much as I do. **SOS** has enabled us to have little to no "visible" learning curve. I am learning but it is not through painstaking frustrations."

Edmond Suh, DDS Wake Forest, NC

"To be able to sit down and do one or two units or a quadrant in a couple of hours and have **no temporaries** and the final restoration placed ... magic."

John Cranham, DDS Virginia Beach, VA

SAME DAY DENTISTRY | EDUCATION | SUPPORT ON SIGHT™

E4D Dentist is designed with the patient and dental professional in mind. The E4D system is an easy to use chairside CAD/CAM system that is empowering modern dentistry. Same day crowns, inlays, onlays, and veneers increase your productivity, provide a tremendous convenience for your patients, and give you complete control of the final restoration. Intuitive and easy to use, the E4D empowers you to create beautiful restorations that provide the form, fit and function you demand and your patients deserve.



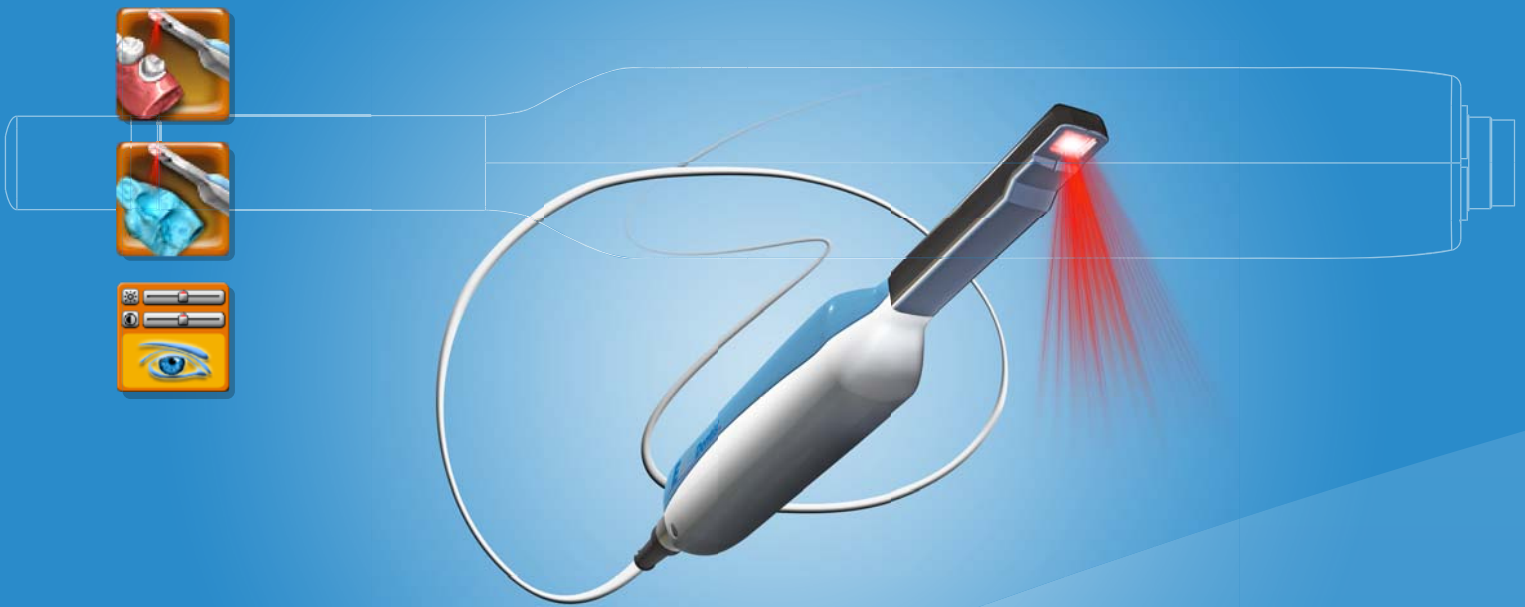

ALL UNITS IN INCHES

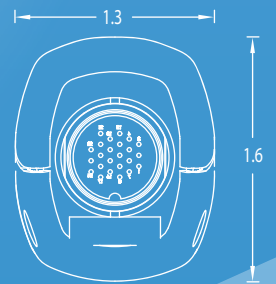
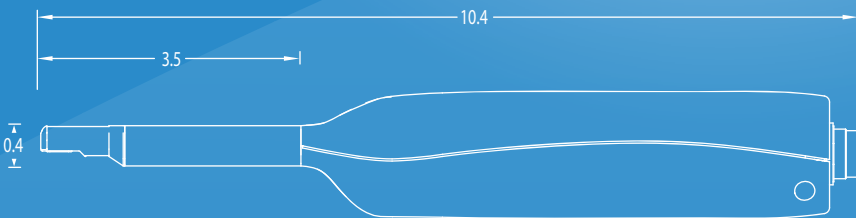

SCAN

DIGITAL IMPRESSIONS | ICEverything™ | PREP, PRE-OP AND BITE

The IntraOral Digitizer (IOD) high-speed laser takes digital scans of the preparation and proximal teeth to create an interactive 3D image. E4D's laser accurately images millions of data points from multiple views with microsecond capture speed, to make scanning easy, fast, and accurate. The ICEverything™ View shows a 3D photograph of the actual dentition that distinguishes hard and soft tissue, well-defined margins, and recreates the oral environment. As you take successive pictures from different angles, the software builds a library of images that "wrap around" the virtual model.



SETUP SCREEN



LASER SCANNER



LIVE VIEW



ICEverything™ VIEW

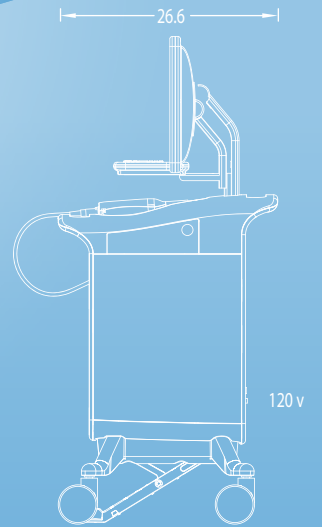
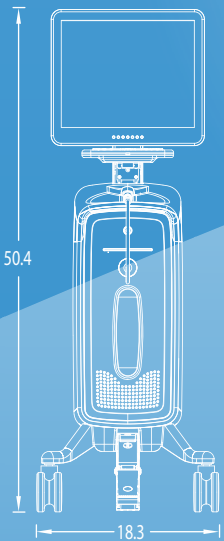

DESIGN

INTUITIVE | AUTOGENESIS™ | AUTOMATIC OCCLUSION

The E4D Design Center, powered by DentaLogic™ software, guides the operator from scanning to milling. Autogenesis™ customizes the proposal for the preparation based upon library teeth created by leading dental professionals. Autogenesis positions and shapes the initial tooth template to match central grooves, cusp heights, and marginal ridges of proximal teeth. Multiple design tools are available including Rubber Tooth™, which enables you to push and pull the proposal as if it were made of rubber. Automatic occlusion automatically adjusts proximal and occlusal contacts per the user-defined parameters. The graphical interface, familiar workflow, and dentist-designed tools make the E4D Dentist system the logical chairside CAD/CAM solution.

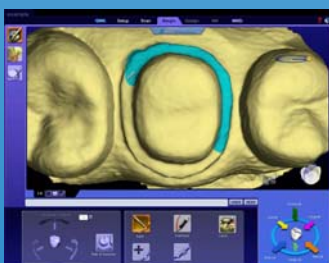

PAINT MARGIN



RUBBER TOOTH TOOLS

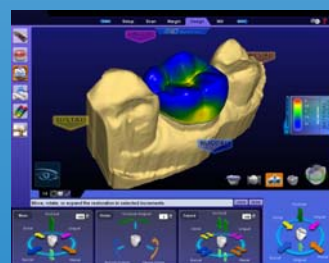

MATERIAL THICKNESS

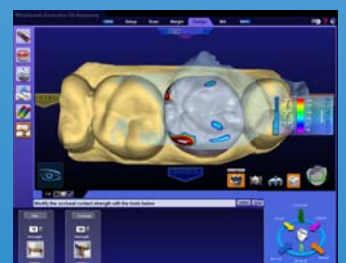

DESIGN OCCLUSION

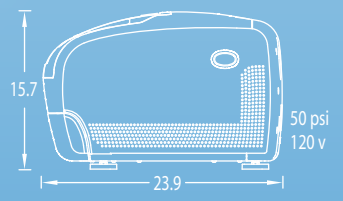
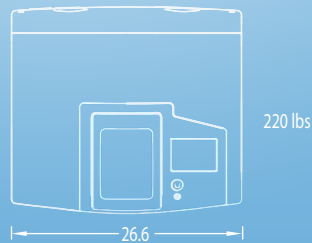

MILL

AUTOMATIC TOOL CHANGER | CUSTOM MILL PATHS | HIGH PRECISION

The E4D Milling Center receives designs from the Design Center via wired or wireless connection and mills restorations from a variety of materials offered by 3M ESPE and Ivoclar Vivadent. Customized, certified milling paths are created for each material type to optimize milling performance and restoration integrity. Dual spindles simultaneously mill both sides of the restoration using Premier Dental tools. The automatic tool changer enables the system to switch tools or replace worn tools automatically. The graphical interface and touch screen make the mill easy to operate. The Milling Center's robust and heavy-duty design reduces vibration for high-level accuracy and material performance.



HEAVY DUTY DESIGN



AUTOMATIC TOOL CHANGER



LCD TOUCH SCREEN



PRECISION MILLING

E4D Dentist™



is more than just a product,

it's an experience.



PARTNERS

D4D's partners in success are Henry Schein for sales and distribution, 3M ESPE and Ivoclar Vivadent for restorative materials, and Premier Dental for milling tools. The partners are contributing to the 360° E4D Experience™ with their high quality, professional products and services. By working with these industry leaders, D4D has accelerated its progress on the path to success and revolutionizing the future of dentistry.

EDUCATION

E4D University delivers a consistent first-rate education program from the people who know the system best. At D4D's 9200 square foot state-of-the-art education facility in Dallas, Texas, the faculty of dental, education, and communications professionals teach the most efficient and effective techniques for optimum E4D Dentist utilization.



SUPPORT



The unique SOS - Support on Sight - remote access capability enables customer support representatives to provide training and troubleshoot issues by remotely observing or operating your E4D Dentist system.

EXPERIENCE THE EXPERIENCE

**For more information about E4D Dentist,
call 1-800-645-6594 (Canada 1-800-737-5029),
or visit www.d4dtech.com.**

